

CRYSTAL STUD PLRE4

DATASHEET

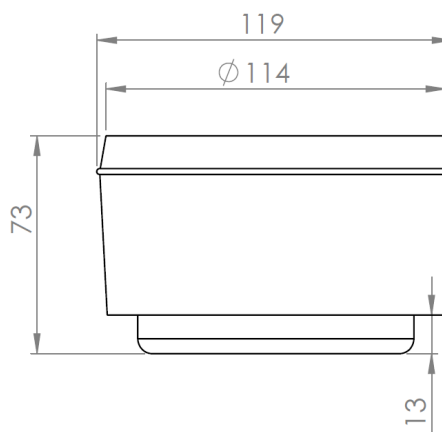

PRODUCT SPECIFICATIONS

Usage: Solar outdoor marking with no cabling.

Structure: Tempered glass frame thickness 15 mm + aluminum tube.

LEDs' color: Colors RGB + White 4000 K.

CRI of the white LEDs: minimum 80.

Outflow: 4 lm.

Battery LiFePO4 (3.6 Ah).

Solar panel Sunpower Back Contact.

Operating temperatures: - 10°C / + 60°C.

Dimensions: 119 x 72 mm.

Weight: 1.25 kg.

Resistance to compression (EN62262 - IK10): 3 tons (suitable for the passage of vehicles of 32 tons maximum).

Class III - IP67 - IK10 - CE.

AUTONOMY

Battery capacity: 3.6 Ah.

Autonomy: 480 hours.

Embedded intelligence allowing optimal management of the battery according to the environment of the stud for operation 365 nights per year.

Battery lifespan estimated at 22 years: 8000 cycles for a depth of discharge not exceeding 55 % (this corresponds to 8 hours of use per night in Paris, with 50 % sunshine during the day).

CONNECTION

Bluetooth connection for a remote control of the product via the application Nowatt Lighting.

Application Nowatt Lighting on Smartphone, available on Android and iOS.
The connection is protected by a code.



FEATURES

ON / OFF function of the device.

Grouping: Creation of groups for simultaneous control of Crystal studs (within the range of Bluetooth).

Demo mode: The stud lights up in forced operation until the user turns it off or applies a scenario.







Setting of the light scenario among 8 standard scenarios.

Setting the operating time (for all nights):

- Number of hours from sunset.
- Number of hours before sunrise.

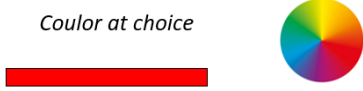
Import of new specific scenarios on request, provided by Nowatt Lighting.

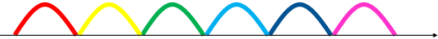
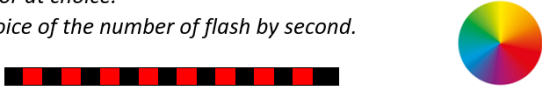
LUMINOUS SCENARIO

<p>Rainbow Chain</p> 	<p>Rainbow Gradient</p> 
<p>Monochrome Candle <i>Color at choice.</i></p> 	<p>Monochrome <i>Color at choice</i></p> 
<p>Rainbow Flash <i>Choice of the number of flash by second.</i></p> 	<p>Rainbow Wave</p> 
<p>Monochrome Flash <i>Color at choice.</i> <i>Choice of the number of flash by second.</i></p> 	<p>Monochrome Wave <i>Color at choice.</i></p> 



INSTALLATION

The methodology for installing Crystal Studs depends on the type of soil. Please refer to our manual available on request.

WARRANTY

Product guaranteed for two years in accordance with the warranties of the French lighting union.